

## SUMMARY

### # Wires

Low	8
High	0
Coax	0
Triax	0
Quad	0
Fiber	0
Fluidic	0



*Image is for illustrative purpose only*

### Download

[Request a quote](#)

[Catalog](#)

### Series

Termination type	Female crimp
IP rating	50
Cable Ø	5.30 - 6.20 mm
Matching parts	EGJ.2B.308.CYC
Status	
Alternative part	

## TECHNICAL DETAILS

### Mechanics

Shell Style/Model	FG*: Straight plug, cable collet
Keying	2 keys (alpha=37.5, plug: female contacts, receptacle: male contacts)
Housing Material	Brass (chrome plated) shell and collet nut, nickel plated brass latch sleeve and mid pieces
Cable Fixing	∅ 5.3 - 6.2 mm
Variant	

### Performance

Configuration	2B.308 : 8 Low Voltage
Insulator	Y: PEEK for crimp contacts
Rated Current	10 Amps

### Specifications

Contact Type:	Crimp
Max. Matings:	5000
Contact Retention:	30 N
Contact Dia.:	0.9 mm (0.035in)
Bucket Dia.:	1.1 mm (0.043in)
Min. Conductor:	0.25 mm <sup>2</sup> (AWG 24)

Max. Conductor: 0.5 mm<sup>2</sup> (AWG 20)  
 R (max): 4.8 mOhm  
 Vtest (contact-shell): 1950 V (AC), 2800 V (DC)  
 Vtest (contact-contact): 1950 V (AC), 2750 V (DC)

## Others

Humidity (max): <=95% [at 60 deg C / 140 F]  
 Vibration: 15 g [10 Hz - 2000 Hz]  
 Shock Resistance: 100 g [ 6 ms]  
 Salt Spray Corrosion: >1000 hr  
 Climatological Category: 50/175/21  
 Shielding (min): 75 dB (10 MHz)  
 Shielding (min): 40 dB (1 GHz)  
 IP Rating: 50

## DRAWINGS

### Draws

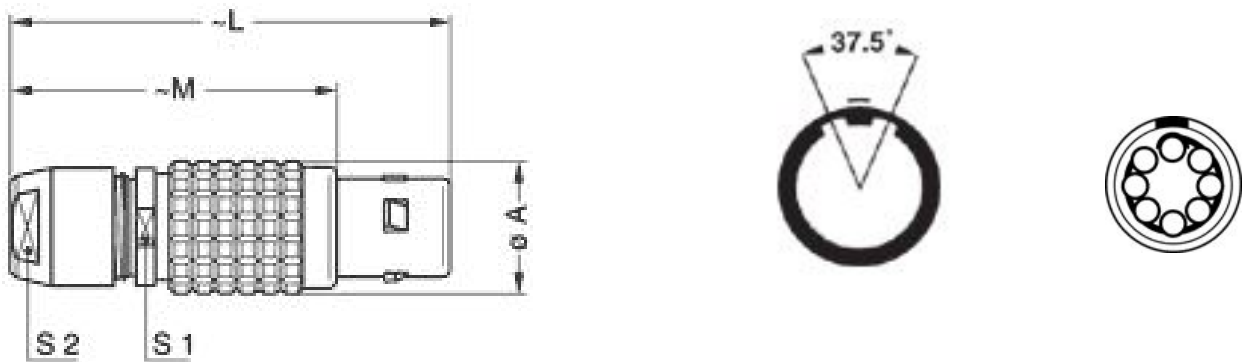

### Dimensions

	A	L	M	S1	S2
mm.	15	50	38	13	12
in.	0,59	1,97	1,50	0,51	0,47









## RECOMMENDED BY LEMO

### Tools

Crimp Tool: DPC.91.701.V  
 Crimp settings: AWG/Selector = 20-22-24/6-5-5  
 Positionner: DCE.91.092.BVM

Extractor: DCF.91.090.2LT  
 Replacement contact: EGG.2B.660.ZZM  
 Spanner wrench: MTZ.2B.220.120

## Cables

CMN.08.T22.059PGCE	PVC	GREY	
CMN.08.T22.059PGZE		Grey	
CMN.08.T22.059PNCE	PVC	Black	
CMN.08.T22.059PNZE			
CMN.08.T22.059QGC	TPR	Grey	
CMN.08.T22.059QGZE	TPR (medical)	Grey	
016 080	PVC	Grey	
042 265	PVC	Yellow	
080 140	PVC	Grey	
180 240	PVC	Black	
180 260	PVC	Black	
335 991	PVC	Black	